



DMMA Series



FEATURES

- Low loss realized with low DCR.
- High performance realized by metal dust core.
- Ultra low buzz noise, due to composite construction.
- 100% Lead(Pb)-Free and RoHS compliant.
- AEC-Q200 qualified
- Operating temperature: -55 to +125 °C (including self-temperature rise)
- Quantity: 600PCS

APPLICATION

- Automotive applications

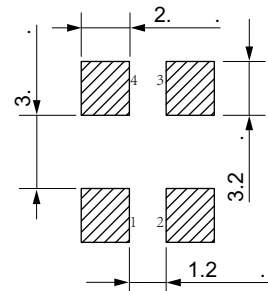
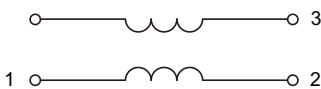
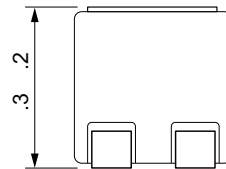
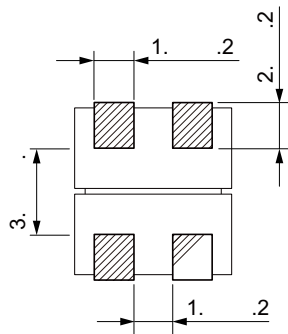
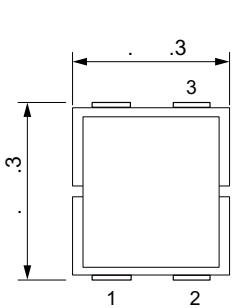

Part No	Inductance @ 100KHz/1V (μH)	Tolerance	Temperature Rise Current Typ. (A)	Temperature Rise Current Max. (A)	Saturation Current Typ. (A)	Saturation Current Max. (A)	DC Resistance Max. (mΩ)
DMMA 7078-1R0M	1.0	±20%	9.8	8.8	19.3	16.5	6.5
DMMA 7078-3R3M	3.3	±20%	5.7	5.1	13.0	11.1	19.2
DMMA 7078-100M	10.0	±20%	3.5	3.2	6.8	5.8	49.0
DMMA 7078-150M	15.0	±20%	2.7	2.4	6.0	5.1	90.0
DMMA 7078-220M	22.0	±20%	2.2	2.0	4.3	3.7	134



3 %



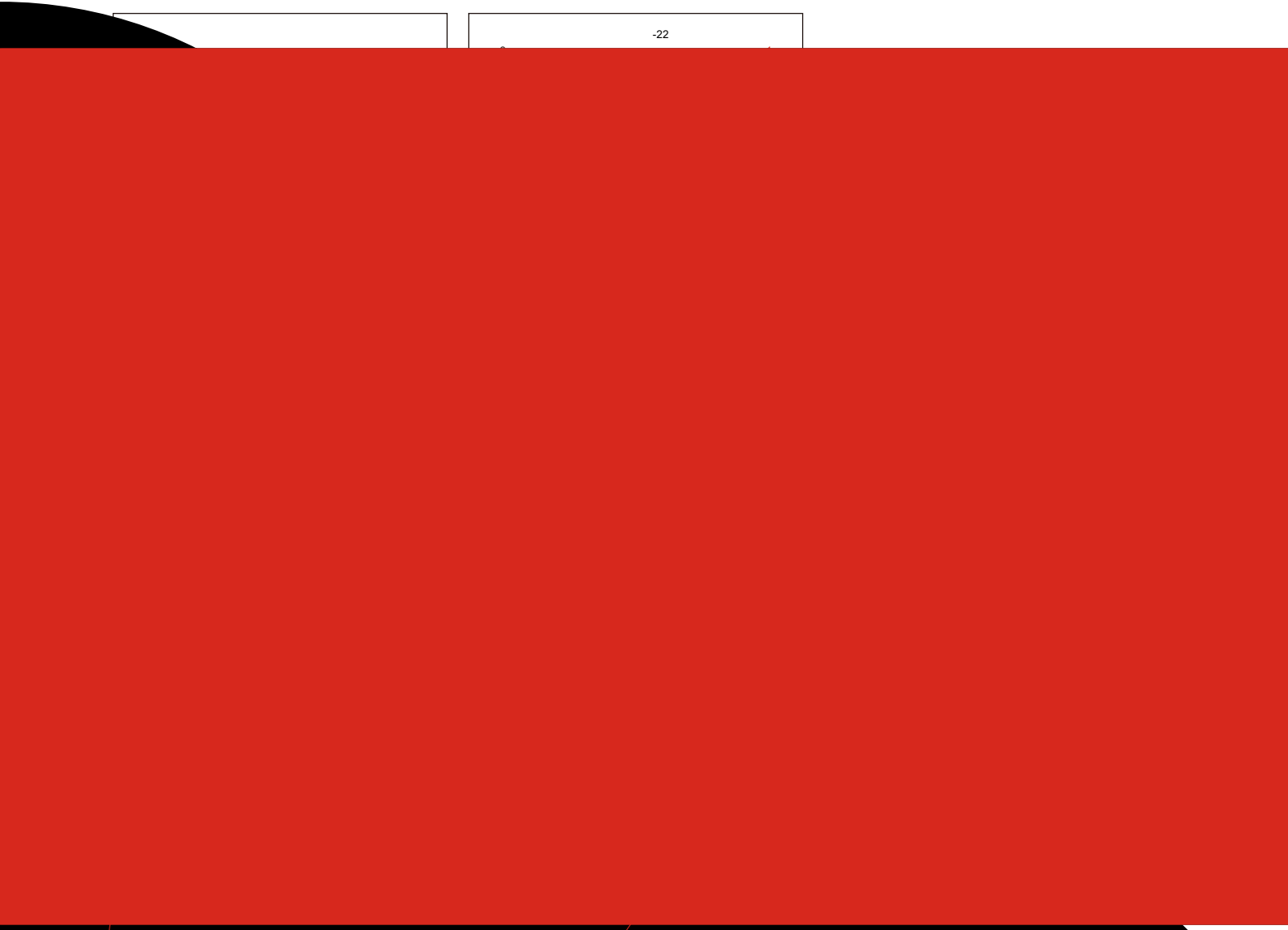
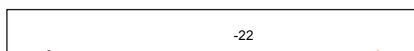
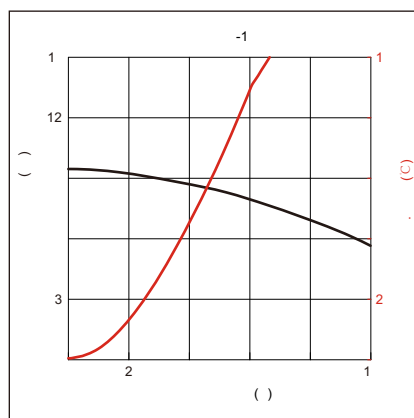
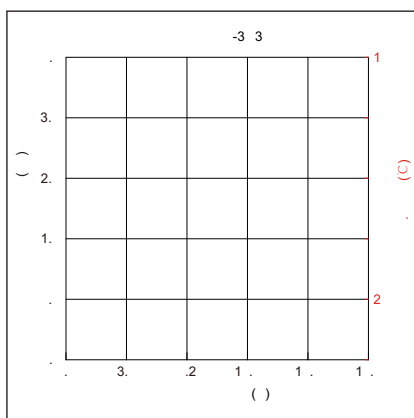

1 \square 2 C 12 .
 21 C 1 .
 2 C .

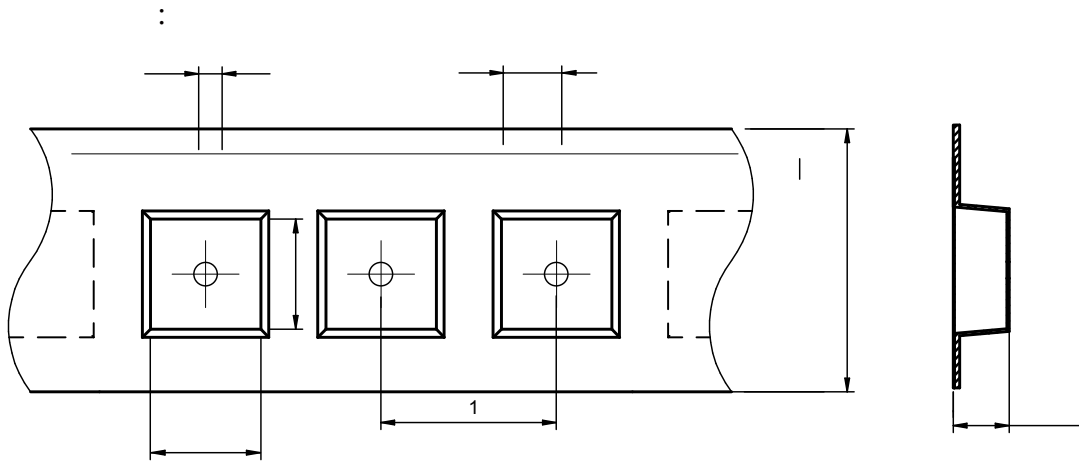

	()	()	()	()	¹ ()	()	()	()	()
DMMA7078	8.1±0.1	7.3±0.1	1.50±0.1	4.0±0.1	12.0±0.1	24.0±0.3	7.8±0.1	1.75±0.1	0.5±0.1

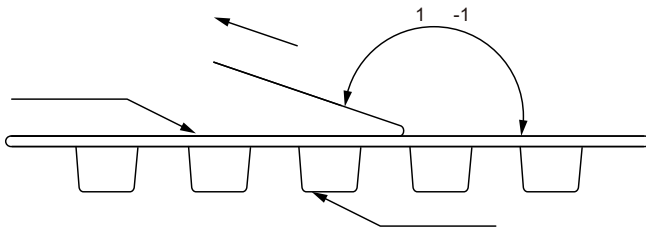

The peel force of top cover tape shall be between 0.1 to 1.3 N

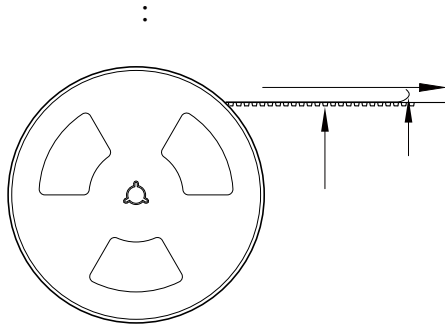

2.2 1.

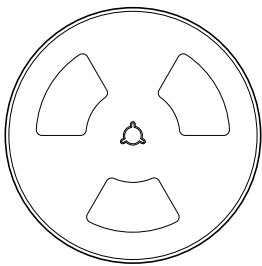
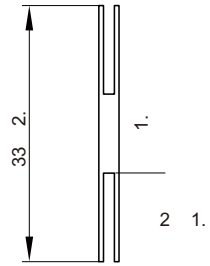

600 Pcs/Reel

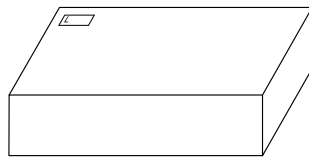

2 Reel /Inner box(1200Pcs)

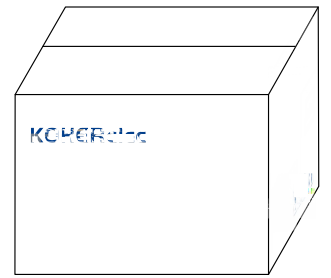

3 Inner box/Carton box(3600 Pcs)

• (12 3 , %) . , -

• , ,

• , ,

• () , ,

• , , 1 .

• , , ,

• , , ,